



# Operating instructions

(Translation of the original operating instructions - English)

## Mobile mixer

### LevMix (230 V - EU)

Collomix GmbH  
Daimlerstrasse 9  
85080 Gaimersheim  
Germany  
Tel.: +49 (0)8458 3298-0  
Fax: +49 (0)8458 3298-30  
info@collomix.de  
www.collomix.de

Made in Germany



## Overview of the machine components

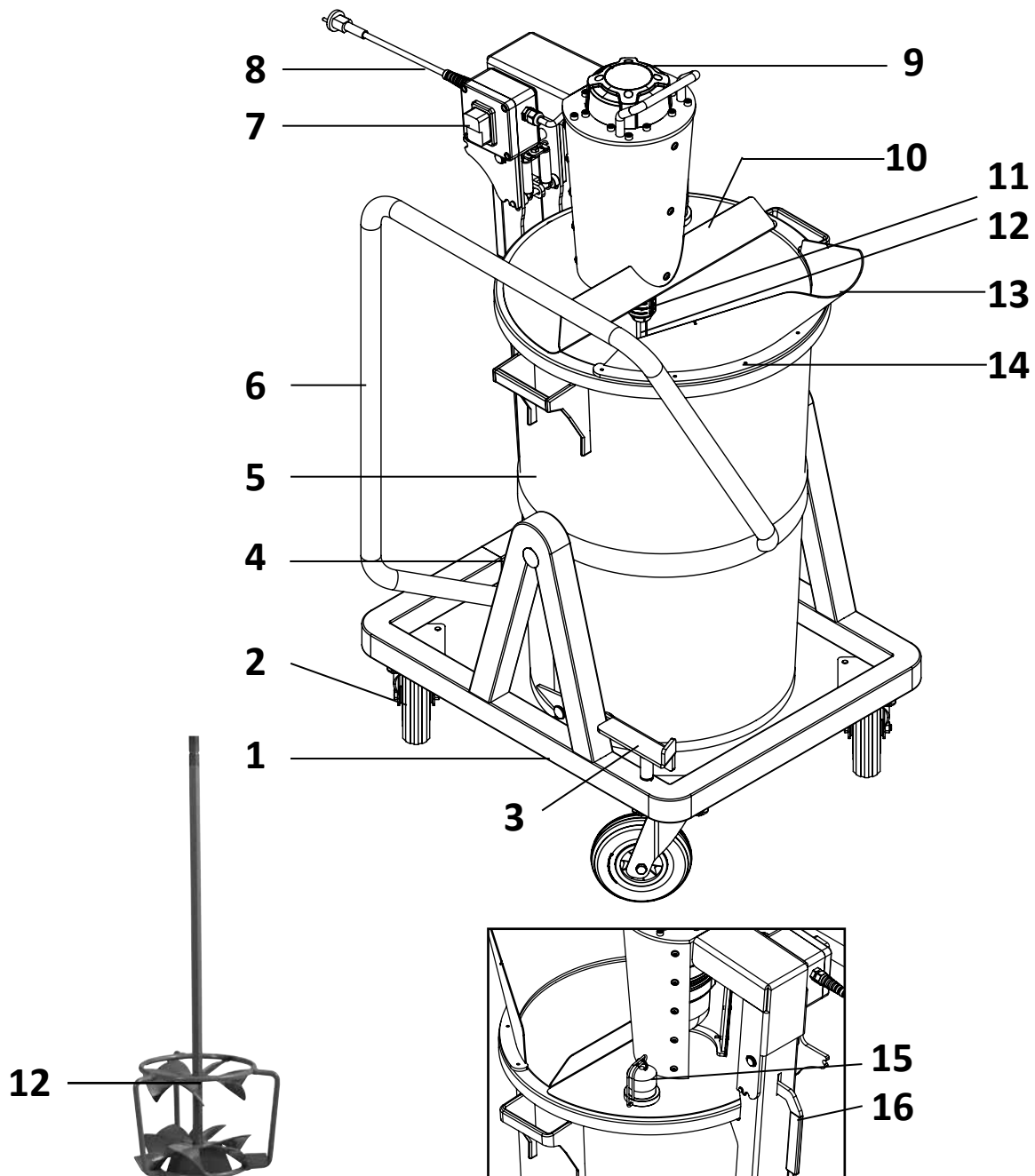

- 1 Trolley
- 2 Rollers, steerable
- 3 Release pedal
- 4 Tub holder, tiltable
- 5 Mixing tub, 75 liters
- 6 Handle
- 7 ON/OFF switch
- 8 230 V connection lead

- 9 Drive motor
- 10 Dust cover
- 11 HEXAFIX quick-action coupling
- 12 Mixing tool VLX 160 HF
- 13 Pouring spout
- 14 Screw connections for spout
- 15 Fitting for vacuum cleaner hose
- 16 Release lever
- 17 Fine-meshed Sieve (extra)

## Technical data

Mixing volume	55 liters / 3 sacks
Capacity of the mixing tub	75 liters
Maximum load	100 kg
Power rating	1600 watts / 230 v
Speed	660 rpm (no load) 410 rpm (under load)
Weight, empty	42 kg
Dimensions	690 x 520 x 1190 mm
Article number of LevMix (230 UK)	37102
Mixing tool	VLX 160 HF
Article num. of VLX	70100
Article num. of the mixing tub (without pouring spout)	70115

## EC Declaration of Conformity

We declare herewith that this product conforms with the following standards and standard-setting documents: EN 12100, EN 60204-1; EN 60745-1:2009; EN 60745-2-1:2010; EN 55014, EN 61000-4 in accordance with the provisions of directives 2004/108 EC, 2006/42 EC, 2011/65/EU



A. Essing, Managing Director



### Technical documentation can be requested from:

Collomix GmbH  
Abt. Technische Entwicklung  
Daimlerstr. 9, 85080 Gaimersheim  
Germany

## Supply scope

Machine with mixing tool DLX 152 HF-VM  
1 75 liter special mixing tub with pouring spout  
1 Set of operating instructions

## About this document

Symbols and accentuations are used in this document to enable you to find information quickly and easily. Read the explanations for them in the following section. Read the safety instructions and warnings contained in these instructions with particular care. The safety instructions start on page 6. The warnings are contained in the introductions to the chapters and also come before instructions for action.



Collomix GmbH owns the copyright to all text and pictures.

It is essential that you read the operating instructions before initial start-up. Follow the safety instructions. Keep safe for future use. This documentation is not subject to review by the revision service.

## Signs and symbols

### Warnings

The following symbols and signal words are used in this documentation.

Symbol	Meaning
<b>DANGER</b> 	When this signal word is used, fatal or severe physical injuries will occur if the relevant precautions are not observed.
<b>WARNING</b> 	When this signal word is used, fatal or severe physical injuries could occur if the relevant precautions are not observed.
<b>CAUTION</b> 	When this signal word is used, minor physical injuries could occur if the relevant precautions are not observed.
<b>ATTENTION</b>	When this signal word is used, malfunctions or damage to property could occur if the relevant precautions are not observed.
<b>IMPORTANT</b>	When this signal word is used, it is followed by information to facilitate operation or by cross-references.

### Structure of warnings

#### DANGER

The first line describes the type and source of danger

The second line describes the consequences if no measures are taken to avert the danger..

→ The last line describes measures for averting the danger.



#### WARNING

Risk of injuries due to disregarding the safety symbols



Disregarding the warnings on the device and in the operating instructions could lead to injuries and further dangers.



→ Observe the warnings on the device and in the operating instructions.



The following special safety symbols are use at the appropriate points in the text in these operating instructions:

**Mandatory sign**

Symbol	Meaning	Symbol	Meaning
	Observe information		<b>Pull out the power plug after use</b> <b>Prior to opening the housing, pull out the power plug.</b>

Symbol	Meaning	Symbol	Meaning
	Warning of a danger point		Warning of dangerous voltage

## For your safety

The “LevMix” mixer has been developed, manufactured and tested in accordance with fundamental safety requirements. An element of risk is still present, however.

- Therefore, read these operating instructions before you work with the machine
- Keep these operating instructions within immediate reach of the machine
- Pass these operating instructions on to the next owner
- In spite of the precautions which have been taken, it is not possible to rule out residual risks which are not obvious. Residual risks can be reduced if the safety and operating instructions are observed and the device is used in accordance with its intended use.

## Safety instructions

**Please read and observe these instructions before you work with the machine! There is a direct risk of personal injury or harm to the health of the user or third party if these instructions are not observed.**

- The machine is to be used and work of maintenance carried out only by persons who have read the operating instructions and who are acquainted with the occupational safety and accident prevention regulations in force in your country.
- Never use the machine if it is not in good working order, use it for the intended use only and have proper regard for safety and danger at all times. All faults which may impair safety must be rectified immediately! Repairs should only be carried out by qualified personnel.
- Wear close-fitting clothing and safety shoes when using the machine and never wear jewelry of any kind. Wear a hair net if you have long hair.
- To provide protection against harmful dust within the area of the machine it is recommended that you use a vacuum cleaner or wear a dust mask.
- Always wear ear protection, protective goggles and safety shoes while working with the machine.
- Make sure the machine stands securely.
- Comply with all electrical regulations applicable to the place of use when you set up the machine.
- Check that the current voltage shown on the rating plate is the same as the mains power supply.
- Keep the device out of the rain or wetness. Water penetration in the electrical equipment will increase the risk of electric shock.
- Always pull out the power plug when not using the machine.
- Never use the cable to pull the plug out of the socket outlet. Protect the cable from heat, oil and sharp edges.
- For outdoor use, use only cables which have been approved for the purpose and bear corresponding markings.
- Never connect the machine to household socket outlets. Always connect machines via an earth-leakage circuit-breaker (RCD) with a threshold current of 30 mA or less.
- If a cable reel is used, the cable must be fully unwound. There is a risk of the cable catching fire from overheating. It can also cause a loss of power which will in turn trigger the undervoltage fuse.
- Never use the machine in any areas where there is a potentially explosive atmosphere. Risk of explosion! Never mix any materials containing solvents with a flash point of below 21°C.
- Do not reach into the mixing container with your hands or any objects while mixing. Risk of crushing!
- Wait until the machine or tool comes to a complete standstill. Rotating tools can snag and cause injuries or damage.
- Always make sure the machine is at a standstill before you ever take any material samples.
- The consequence of deliberately shutting off any of the safety functions is acute an risk of accidents and injury. The warranty will be rendered null and void in this case.
- Never clean the machine with the hose or a high-pressure cleaner - risk of electric shock!
- Electrical equipment must be checked over at regular intervals by an electrician.

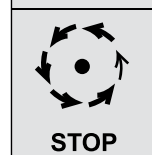
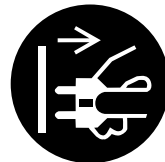

## Intended use

The LevMix is a mixer designed for mixing:

- **low-viscous, self-leveling floor coatings;**
- **cement-based leveling compounds;**
- **liquid plastics**

of the types used in the building trade.

The recommended mixing volume is **a maximum of 100 kg/55 liters per mix (depending on the material)**. It is recommended that you check the amount of time required for mixing by running tests with the required material before you start work.

Please follow the manufacturer's processing instructions for the material used.

Any other use or use over and beyond the above is deemed not to be in accordance with the intended use and therefore misuse. This can have an adverse affect on safety and protection. Collomix GmbH shall not accept liability for any resultant damage. Compliance with the intended use also includes:

- Observance of all the instructions in the operating instructions
- Observance with all safety instructions
- Compliance with inspection and maintenance work requirements.

**The user shall be liable for damages arising from misuse.**



## Foreseeable incorrect use

Reasonably foreseeable incorrect use which could lead to danger or risks for the user, third parties or the machine are as follows:

- The use of the machine and its accessories contrary to the intended use.
- The operation of the machine with a mixing tool which is different to the one specified.
- The use of a damaged container or a container which is unsuitable for the mixer.
- Mixing plastic or high viscosity materials.
- Mixing potentially explosive substances.
- Mixing electrically conductive substances.
- Mixing chemically aggressive substances and corrosive liquids.
- Mixing foodstuffs.
- Operation of the system beyond the physical limits for use specified in the chapter entitled "Initial start-up / Operation"
- Use of the machine without the intended mixing tub or with an unsuitable tub.
- Use of the machine in the maintenance position (drive unit swung up)
- Overfilling the tub
- Use of water jets or high-pressure cleaners for cleaning
- Modifications to the mixer and additions or conversions without prior consultation with Collomix GmbH.
- The operation of the machine contrary to the specifications in the operating instructions relating to safety instructions, installation, operation, servicing and maintenance, setting up and faults.
- Bridging or deactivation of safety and protective precautions on the machine.
- Operation of the machine with obvious faults
- Repair, cleaning and maintenance work without the mixer having been disconnected from the mains power supply

## Transportation instructions

The machine is delivered ready for use in cardboard packaging on a pallet.

The machine comes with 4 steering rollers to enable it to be moved by a single person on firm, level ground. It also has a braking roller to stop it moving.

The machine has a weight of 42 kg when empty.

The machine must always be properly secured with several transport straps when transported in order to prevent it from toppling over or rolling away. If it is not secured it could cause serious injury to persons and damage to property.

Transport the machine in an upright position.

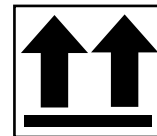

## Working principle

The machine is comprised of a mobile frame with a tiltable mount for a mixing tub. The upper section holds the drive motor for the mixing apparatus which leads into the middle of the mixing tub.

The mixing tub is first filled with the required amount of water, followed by 2 - 4 sacks of powdery material, depending on the fill quantity, with the mixer running.

The material should be ready for use within three minutes. Please observe the information issued by the manufacturer of the material.

To pour the material, release the mixing tub and tilt it.

The right fill quantity varies according to the density and viscosity of the material. To achieve the optimum quality it is recommended that you carry out a test mix first.



## Initial start-up

Check that the power supply shown on the rating plate is the same as the mains power supply. Connect the machine power cable to the mains power outlet via a suitable extension cable (type H07 RN-F, min. diameter 1.5<sup>2</sup>). This must have a fault current circuit-breaker (e.g. earth-leakage circuit-breaker/RCD).

Check that the mixing tub is correctly held in the mount and that the tipping device is locked. Also check that the cover plate is on the tub and is locked.

If you connect an external dust extractor, connect the extractor hose to the hose fitting on the cover.



## Mixing tool and HEXAFIX coupling

The DLX mixing tool is specially designed for liquid, low-viscosity materials. The high shear forces of the mixing tool break up lumps quickly and produce a homogeneous mix in a short time.

The mixing tool is connected to the drive unit by a HEXAFIX quick-action coupling. It can therefore be fitted and taken out without the need for any other tools.

**Prior to opening the machine, pull out the power plug.**

- The drive unit must be lifted to enable the mixing tool to be removed. To do so, release the lever at the back. Lift the drive unit by the bow-type handle until it engages in the first position.
- Push the red part of the HEXAFIX coupling upwards. This releases the stirrer to enable it to be pulled downwards and out.
- To fit the stirrer, push it into the coupling until it engages in the coupling.
- Release the cover again and close it.

The HEXAFIX has a rubber bushing to protect it from dirt. The bushing can be replaced if required. To ensure that the coupling offers lasting service, apply a little grease (not oil!) to it at regular intervals.

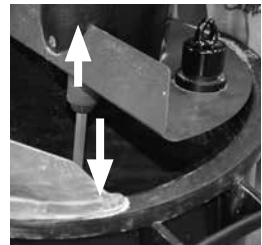
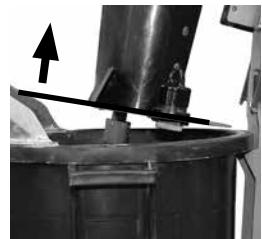
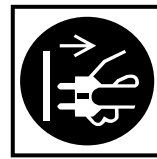

## Mixing tub

The mixing tub has a changeable pouring spout. This is to help pour the mix cleanly and on target.

- To take out the mixing tub you first have to take out the mixing tool (see above).
- Once that has been done, you have to swing the complete drive unit fully upwards. Release the drive element by the release lever and lift it until it engages in the maximum position.
- **CAUTION:** The drive unit is heavy; hold it firmly by the bow-type handle while opening and closing. If not, there is a risk of your fingers getting crushed. Be aware that there is an increased risk of the machine toppling over when it is open.
- To take out the tub: Turn it a little until the handle on the tub is no longer blocked by the handle. Then lift it out of the tub holder.

If a new replacement tub is to be used, the pouring spout has to be switched over. This is fastened to the tub by 6 screws.



## Operation

- To start up the mixer, press the green "I" START button. The mixing tool will start to rotate.
- Switch on the vacuum cleaner if fitted.
- Fill the mixing tub with water and then add the mixing material step-by-step.
- To turn off the machine, press the red "O" OFF button. The machine will run to a stop.
- Pull out the power plug before you start to pour the ready-mixed material.
- Taking the mixer by the handle with both hands, move it to where you want to pour the material.
- To pour, release the mixing tub by pressing the pedal with your foot. Keep hold of the handle with both hands when you do so. Then tip the mixing tub by the handle until material starts to flow out over the pouring spout.
- If you want to distribute the material over a larger area, move the mixer in the direction you require. When doing so, take care to always move away from the fresh material. This is to make sure that you do not move the wheels into the mix.
- Once the mixing tub is empty, move it back into the vertical position again until the foot pedal locks again.

The machine comes with an undervoltage trigger. The machine comes to a stop if this is triggered. This can be caused by the following:

- A drop in the voltage in the mains power supply
- A cable which is too long
- A cut in the power connection

Restart the machine when the fault has been rectified.

### High-quality design floors

If the finished mix has to be screened as well, a fine -meshed sieve must be attached to the spout in order to hold back very small lumps. This is available as an extra accessory (Ref.no. 71064).

### IMPORTANT:

Please observe the information in the technical data sheets issued by the manufacturer of the material.

The amount of time required for mixing will vary according to the quantity and flowability of the material.

For some particularly sensitive surface coverings it can be helpful to pour the mixed material through a screen with a fine mesh. This type of screen can be fitted to the pouring spout (accessory).

Some materials are susceptible to the formation of air inclusions during mixing which do not disappear on their own. To remove them, turn the mixer off for a short time to allow the air to escape. Then restart the mixer and complete the mixing operation.

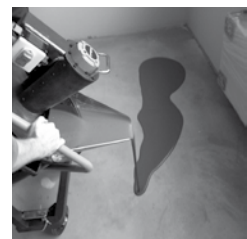

## WARNING

### Risk of injury from the rotating mixing tool.

Do not reach into the mixing compartment or use any tools inside it while mixing is in progress.

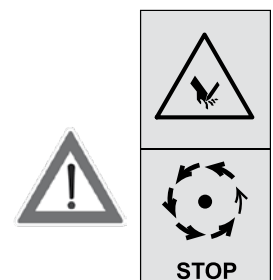

## Care and maintenance

**Before performing any maintenance or cleaning work, always pull the power plug out of the power supply socket.**

Clean the machine immediately after use. Never clean it with running water. The mixing tool can often be cleaned using just a little wet sand in the tub. Let the mixing tool run in it for just a short time and it will be clean.

Keep the HEXAFIX coupling clean and freely moving at all times. Apply suitable grease (e.g. MOXaktiv 250 from OKS; Molykote) to the hexagon mount of the coupling at regular intervals.

Keep the ventilation slits clean and clear at all times so that the machine can be properly cooled. Blocked ventilation slits will lead to irreparable damage to the machine.

Make sure the tipping device and rollers run smoothly and make sure the brakes work properly. Replace all damaged, bent or worn machine parts.

The mixing tool drive unit is equipped with self-deactivating carbon brushes. When the minimum length is reached, the machine is switched off. The carbon brushes should only ever be replaced by a qualified electrician.

Use only a genuine Collomix mixing tub to replace a worn mixing tub. Only by using this tub can it be guaranteed that the machine will work properly.



## Repairs

Repairs or faults in the electrical equipment should only be dealt with by qualified personnel or the Collomix maintenance service.

Only use original Collomix accessories and replacement parts.

### DANGER

#### **Danger to life caused by dangerous electric voltage**

Never under any circumstances open any covers or safety devices on the machine. Repairs may only be performed by trained, qualified personnel. All safety devices and electrical equipment must be checked after repair work to ensure that they are in proper working order, and this must be documented.



Never modify or alter any safety-critical parts!

Additional attachments are not allowed to have an adverse affect on safety and they must be approved by the manufacturer. Hersteller genehmigt werden.

## Consumption material

The following consumption material is available:

Part	Ref.no.
Mixing tub, 75 liters (without pouring spout)	70115
Mixing tool VLX 160 HF	70100
Pouring spout	71061

## Disposal

The machine, accessories and packaging should be properly recycled and never disposed of with household waste.

All items of electrical equipment which are no longer suitable for use can be taken for recycling to the nearest public depot for electrical scrap.

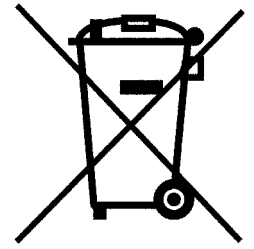

## Warranty

The manufacturer provides a 24 month warranty in respect of all production or material defects. Please note that all warranty claims must be accompanied by a proof of purchase.

Warranty and liability claims for personal or material damages are excluded if attributable to one or more of the following causes:

- Improper use of the machine
- Improper start-up, operation or maintenance of the machine
- Damage caused by excessive accumulations of dirt and/or incorrect cleaning.
- Unauthorized structural modifications to the machine.
- The use and installation of non-original replacement parts.